

# 小學普通畫學本

甲部之二

文部省印行

宮本三平編  
明治十一年六月

東京堂社總刊

K

小學普通畫學本 甲之部 第二

目錄

第三業

第一圖ハ器具ノ正面或ハ側面ノ單圖

第二圖ハ壺類ヲ描ク法

第三圖ハ家屋并鐵橋ノ單圖

附遊戯ノ具并小兒手遊ノ具

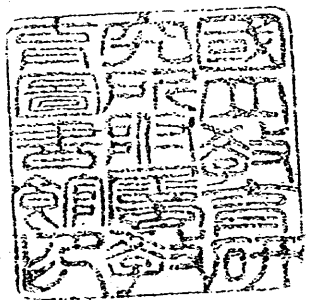

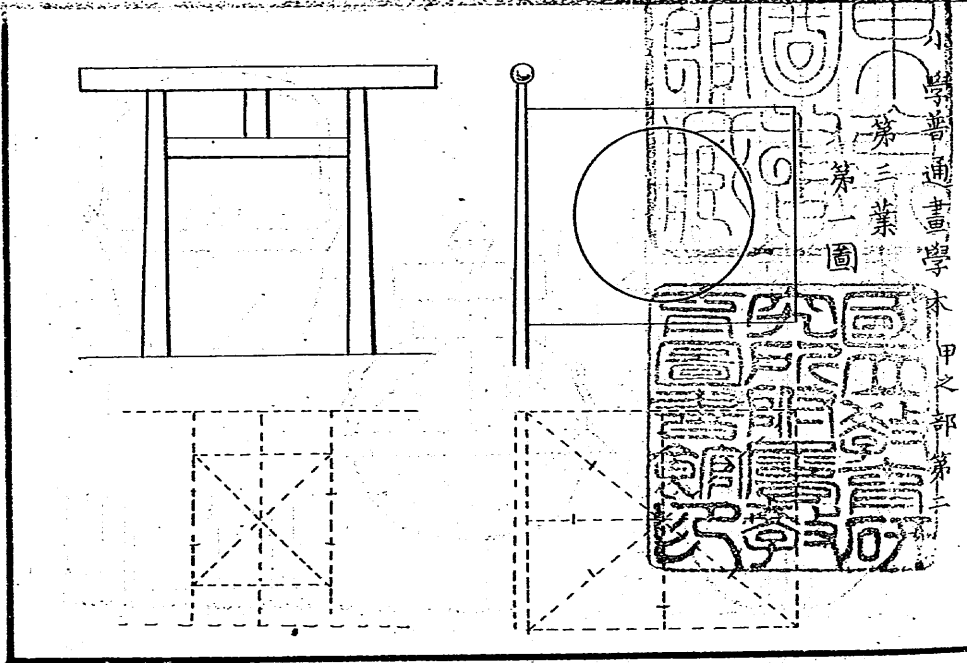

東周

普通畫學  
第三業  
第一圖

甲文部第一

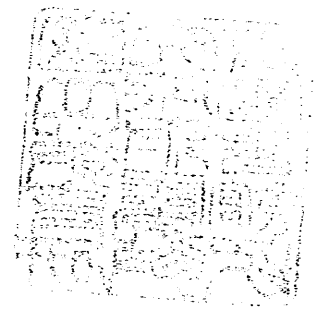

此圖為... 東周... 普通畫學... 第三業... 第一圖... 甲文部第一

三

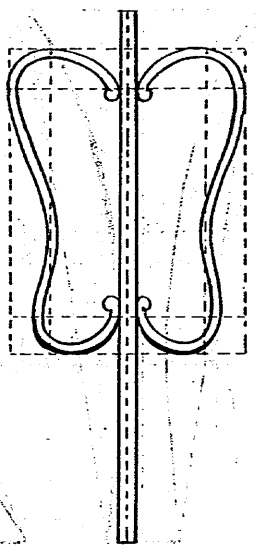
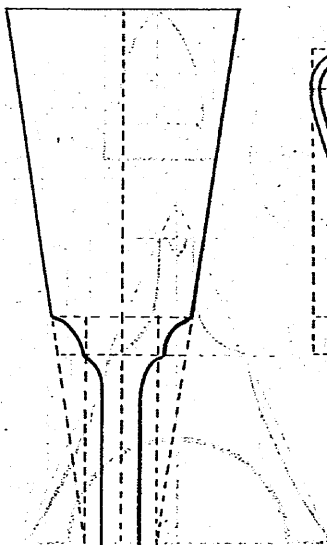
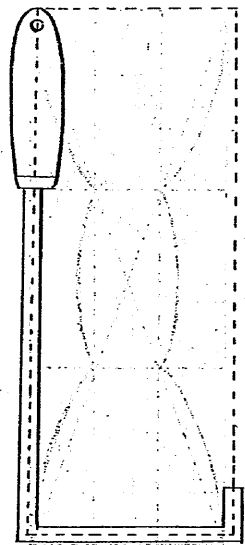

四

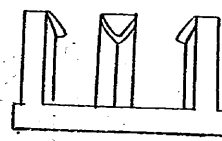
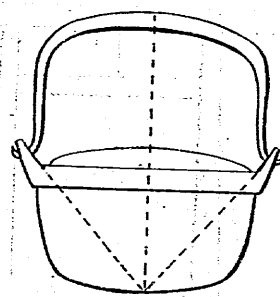
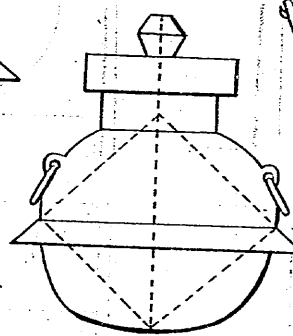
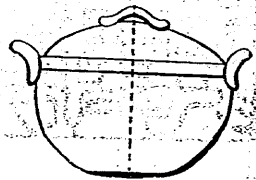
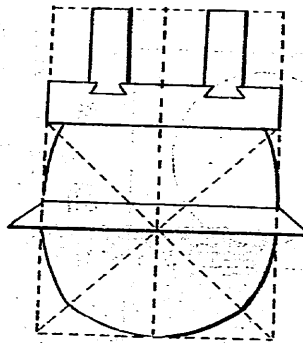

五

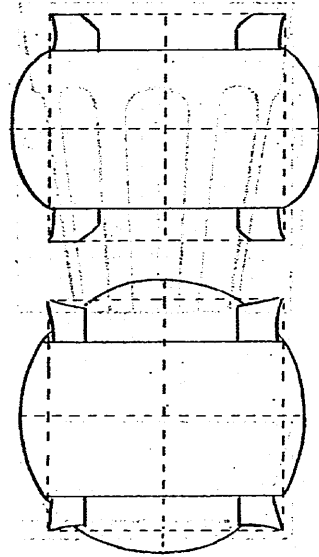
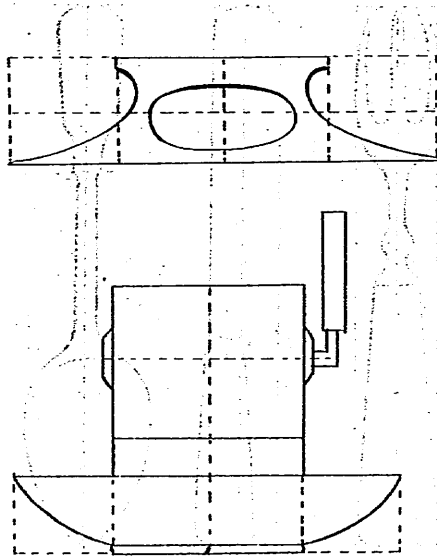

122

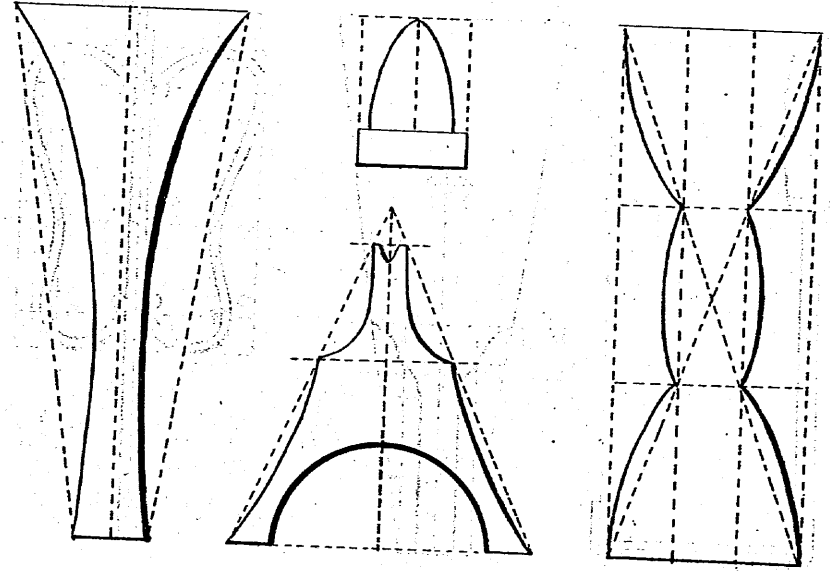

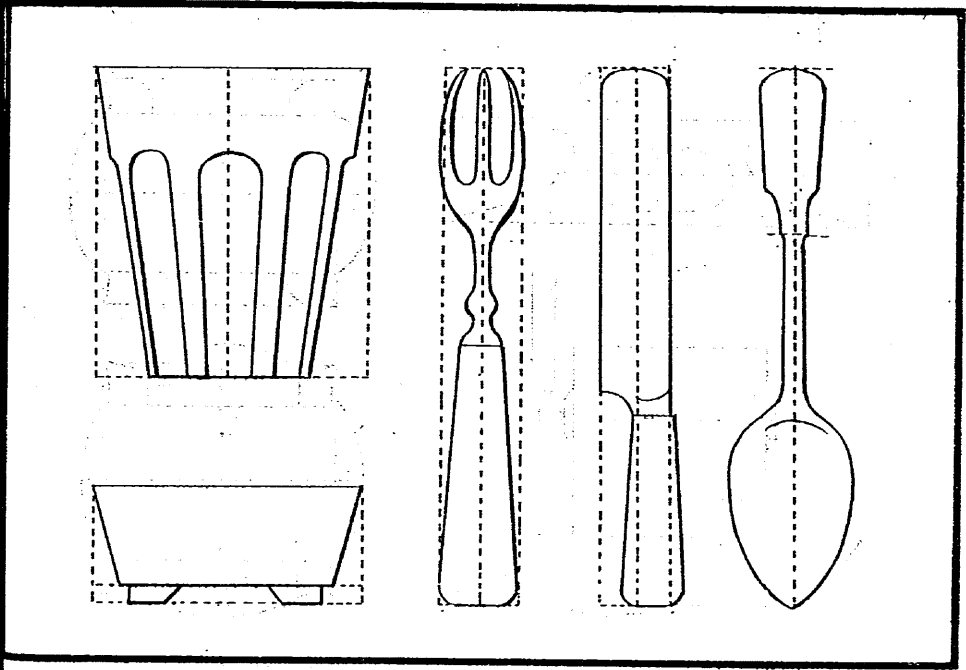
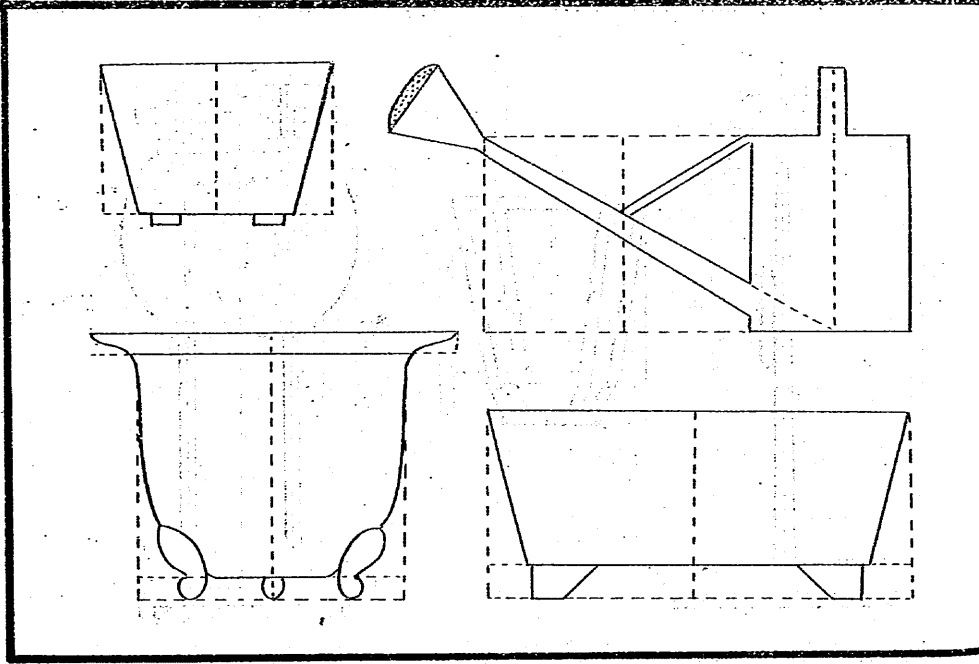

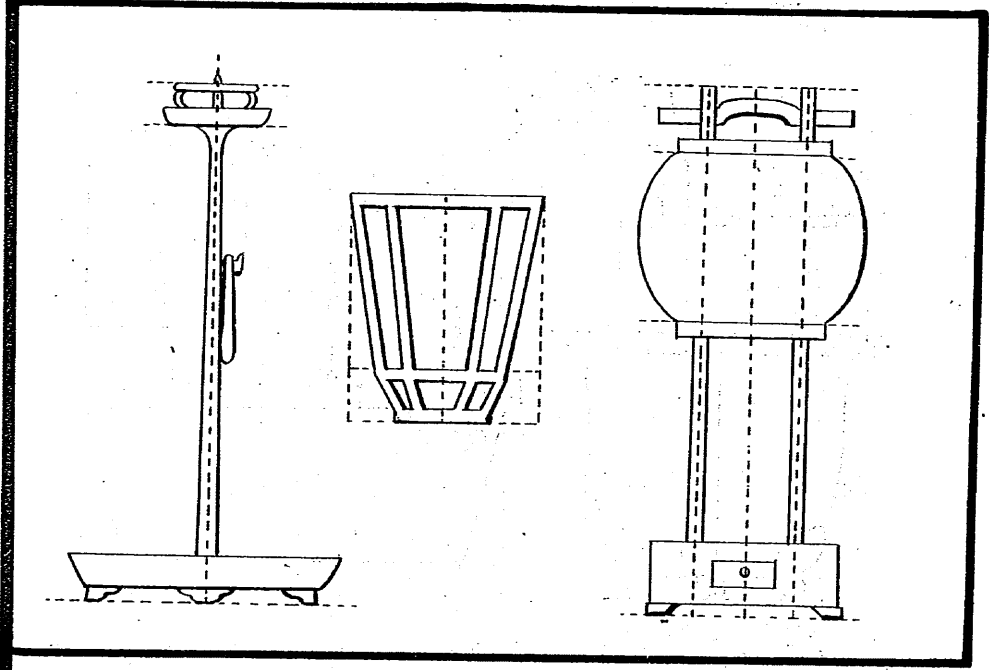
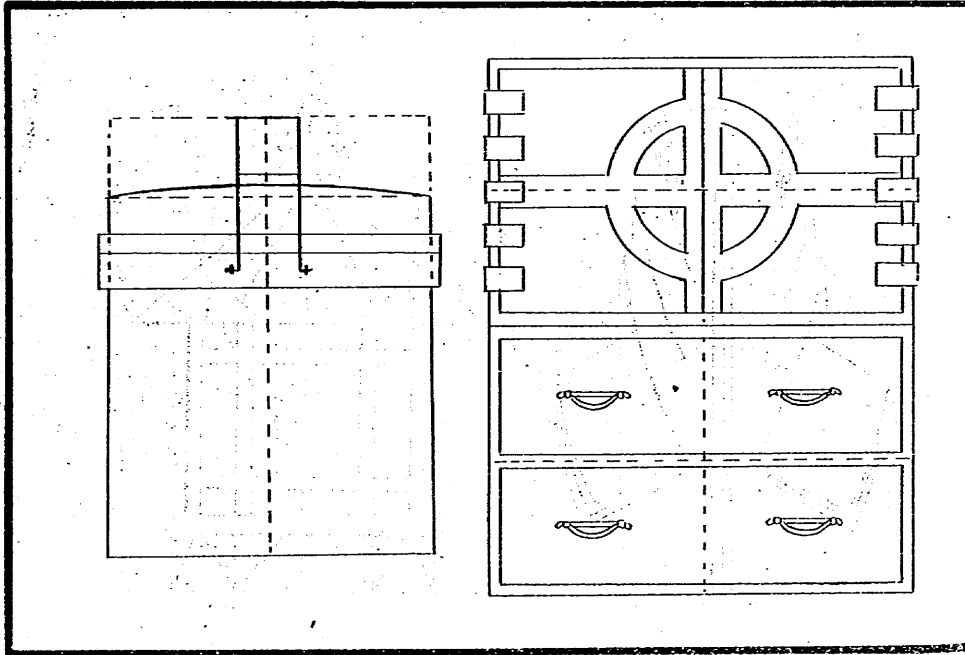

士

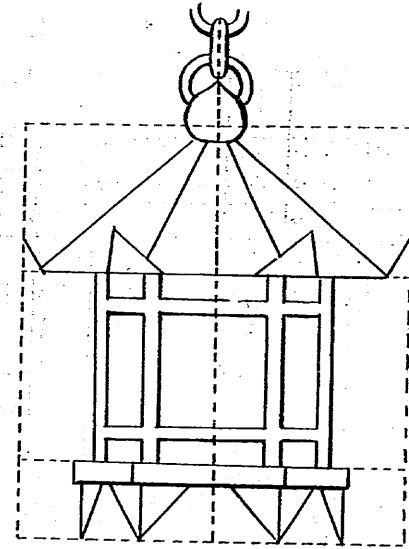
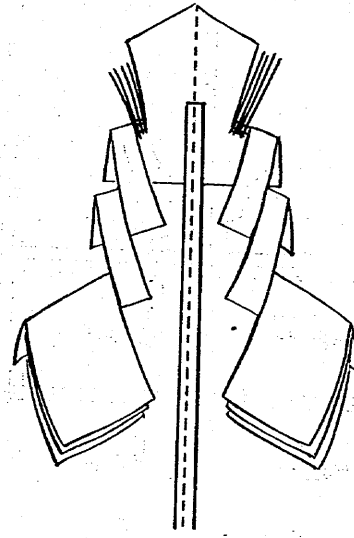
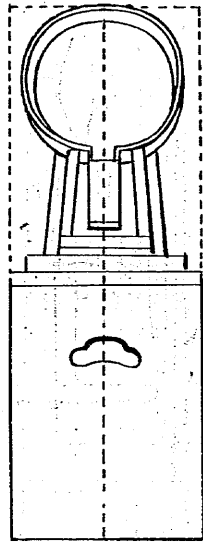
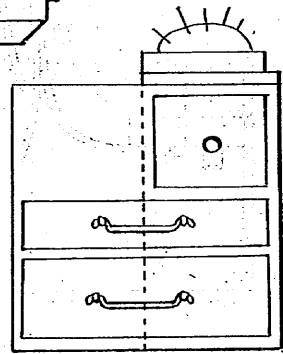
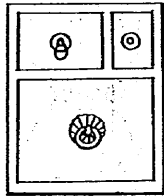
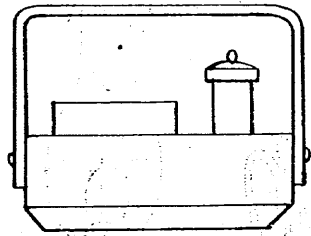

士



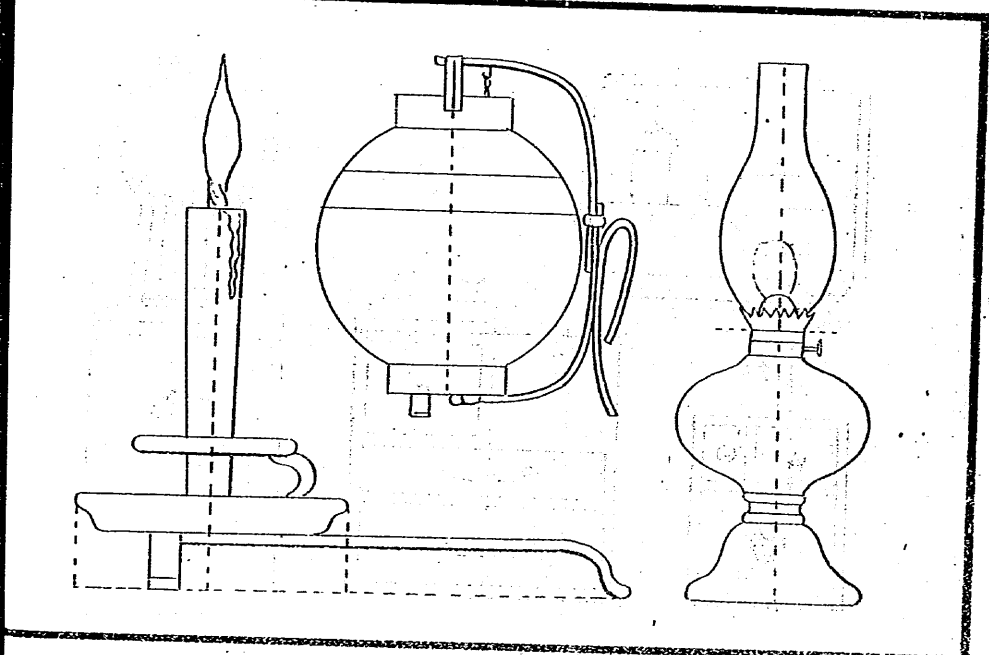
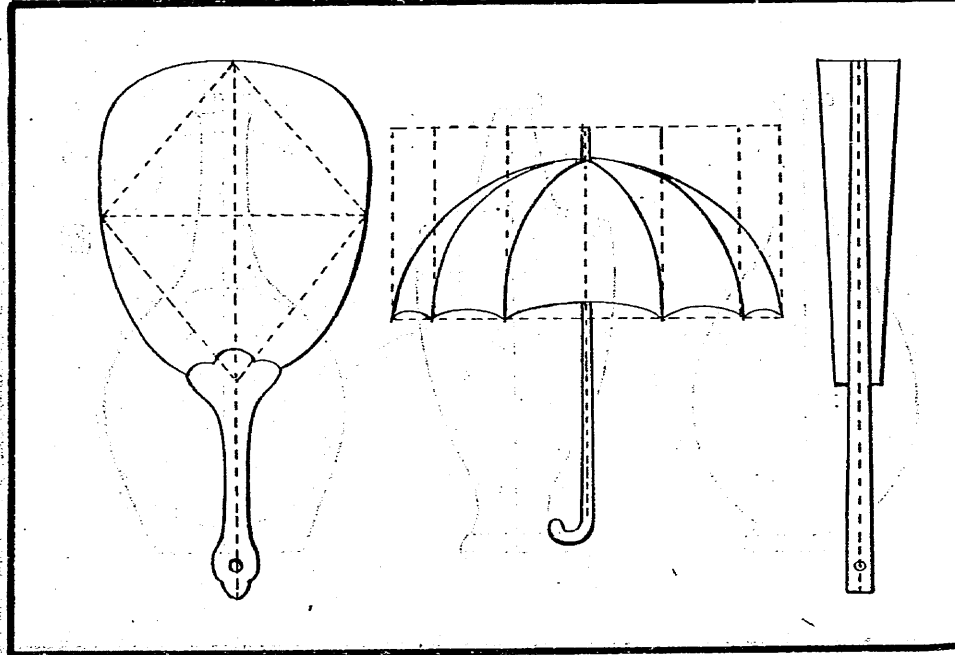

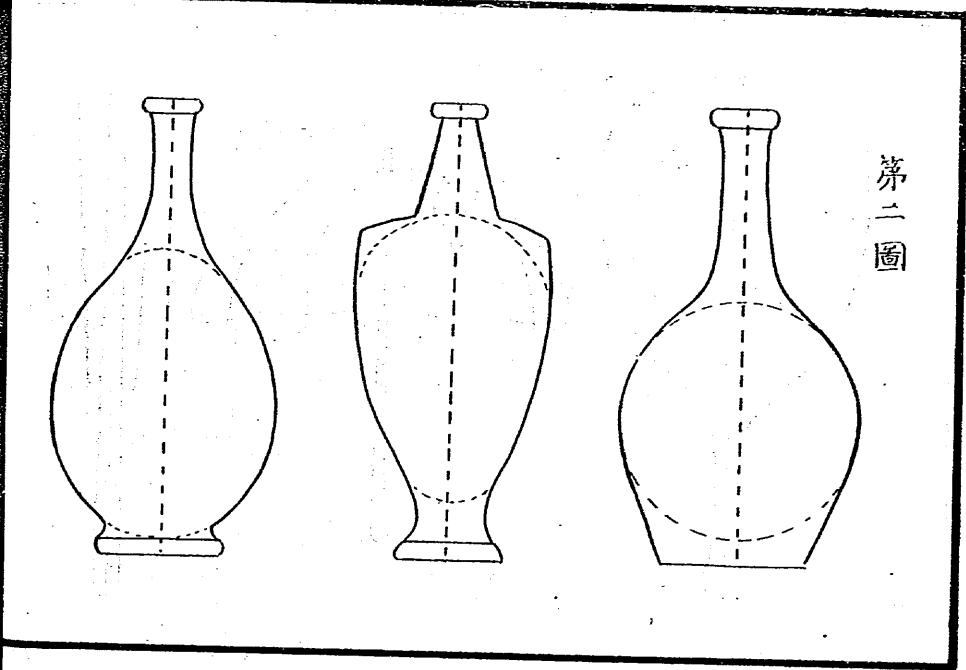
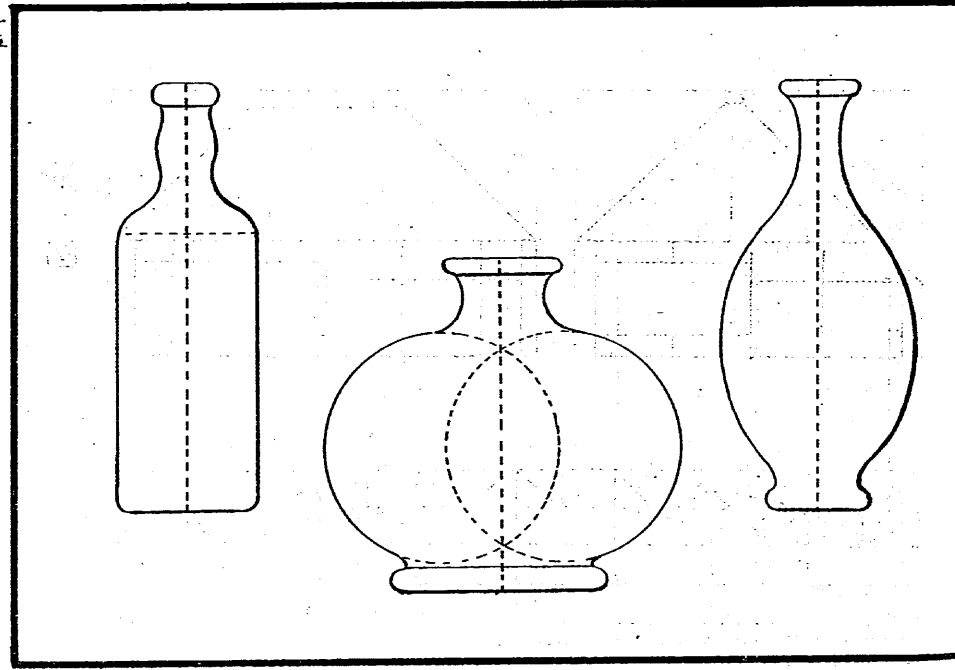

第二圖

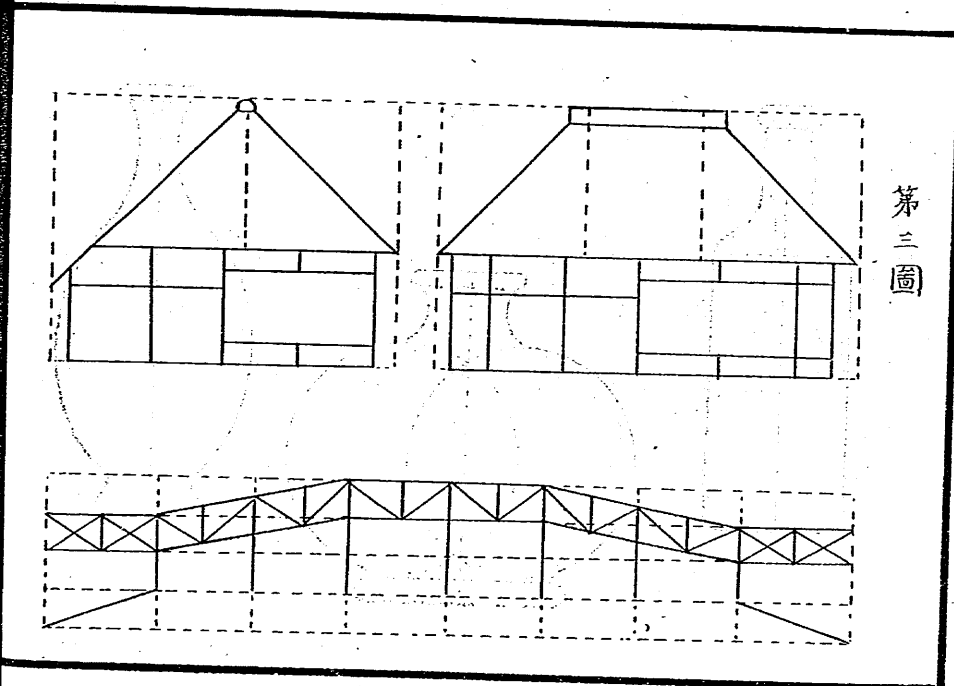
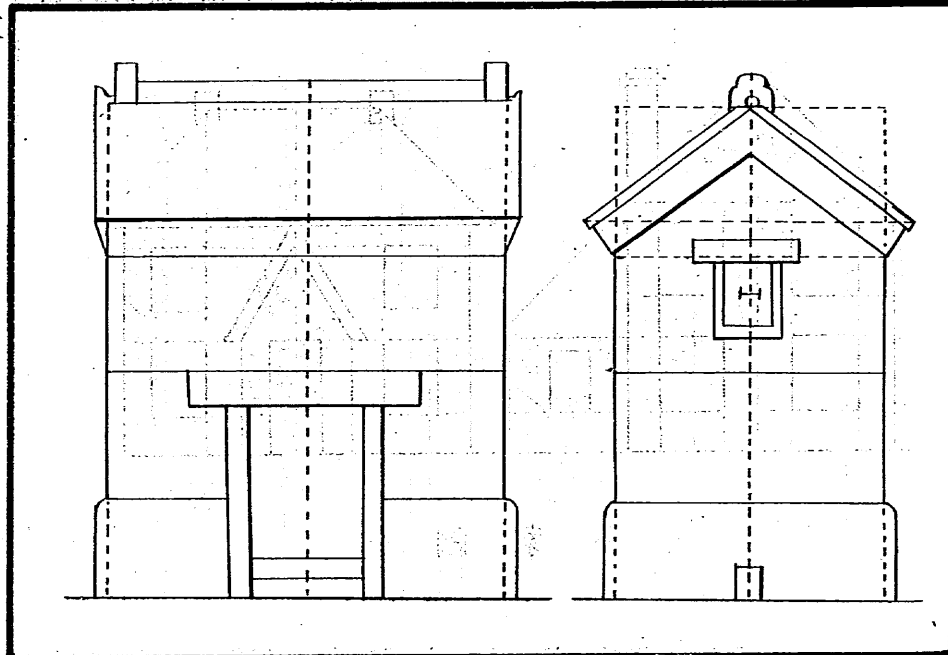

第三圖

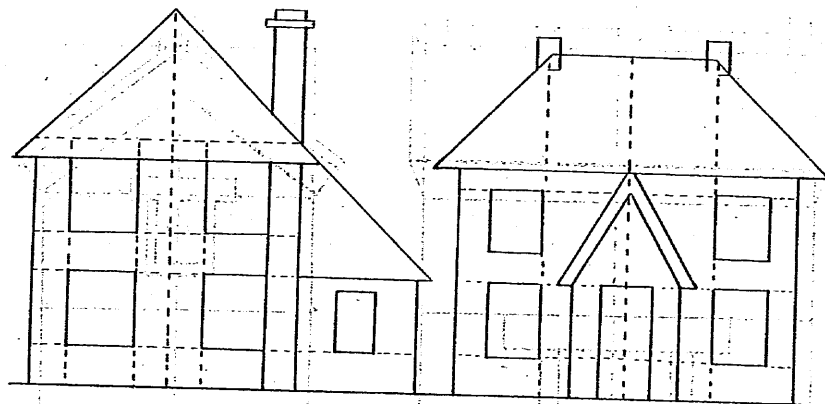
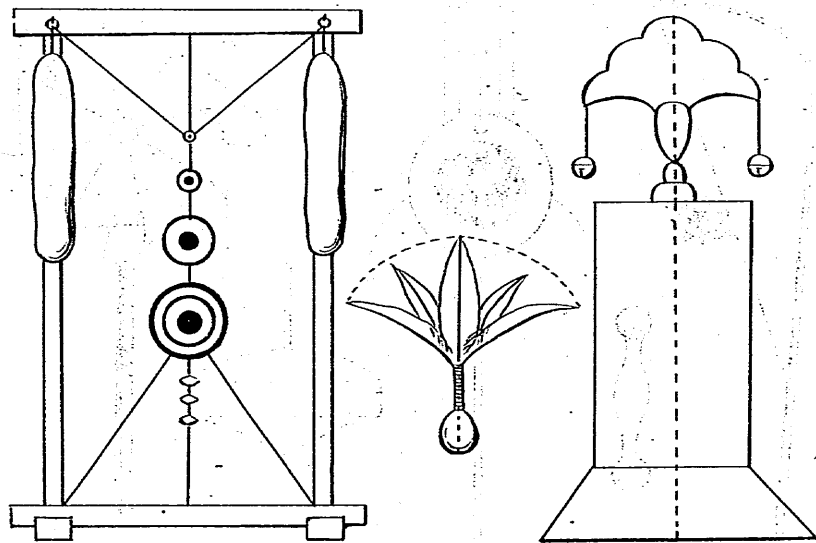

屋 家 國 外

